







Montageanleitung

Art. Nr. 13404

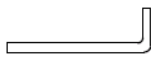
Nummer	Bild	Menge	Nummer	Bild	Menge
A		2	E		16
B		2	F		1
C		16	G		1
D		16			

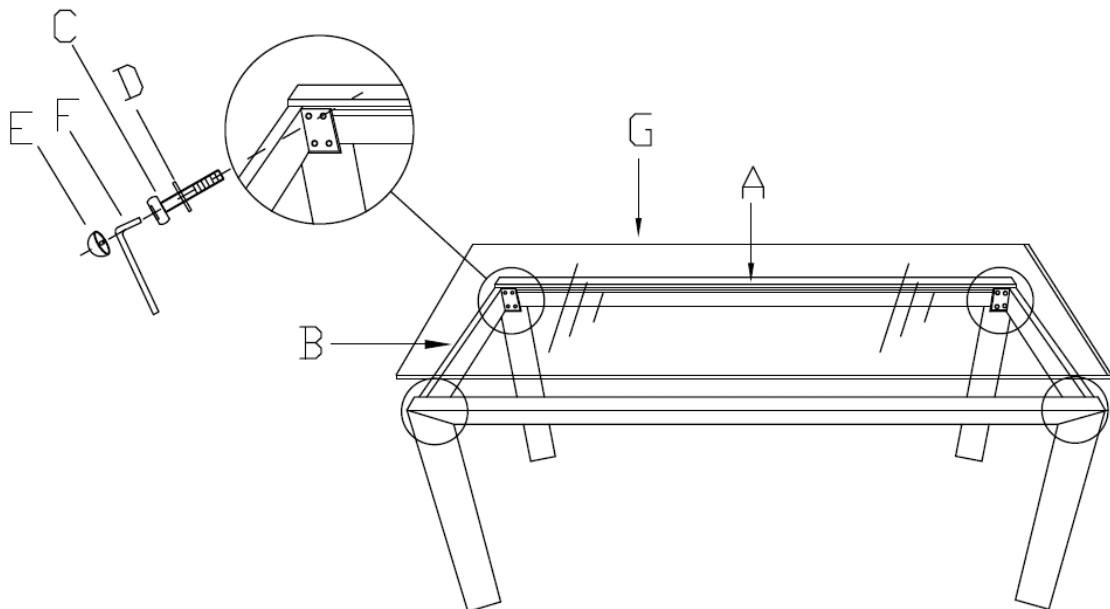

Hinweis:

Ziehen Sie die Schrauben nicht komplett an, bis alle Teile verbunden sind!
 Montieren Sie den Artikel auf flachem, weichem Untergrund.