

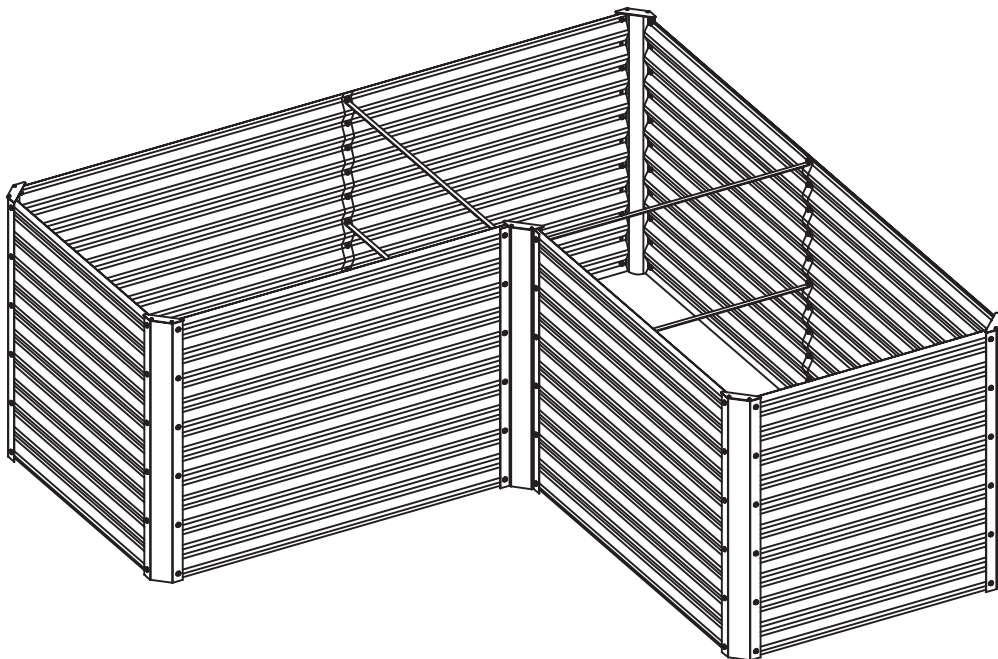











Montageanleitung

Art. Nr. 18169/ 18170



Produktmaße (L x B x H): 210 x 90 x 84 cm

Bitte lesen Sie sich diese Anleitung sorgfältig vor der Montage durch.

Teil	Nr.	Stk.
	L31	5
	L32	1
	Y3	4
1100mm		
	Y2	2
800mm		
	Y11	2
930mm		
	L05	6
	D93	6
	S21	94
	M6X12	
	M11	94
	M6	
	J61	1
8.4m		
	Z02	12
	Ø4X16D	

1 Eck-Hochbeet Montage

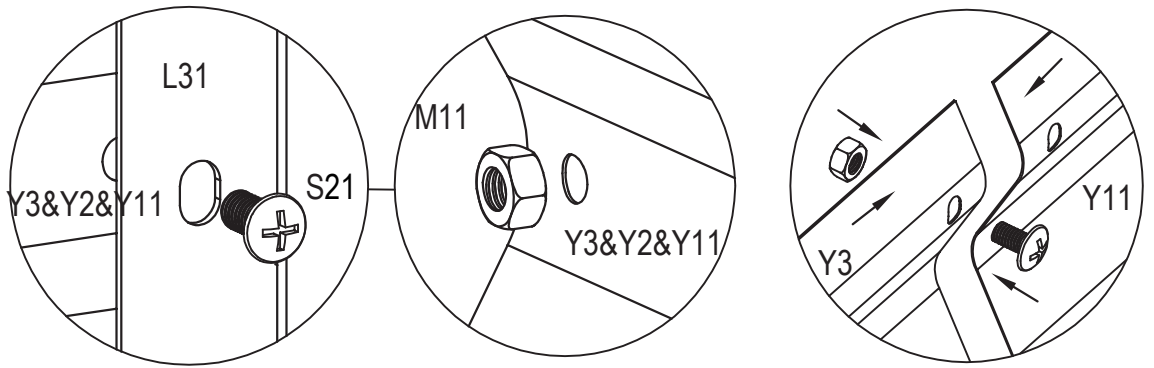

Montieren Sie alle Bleche wie folgt und sichern Sie diese mit den mitgelieferten Schrauben und Muttern.

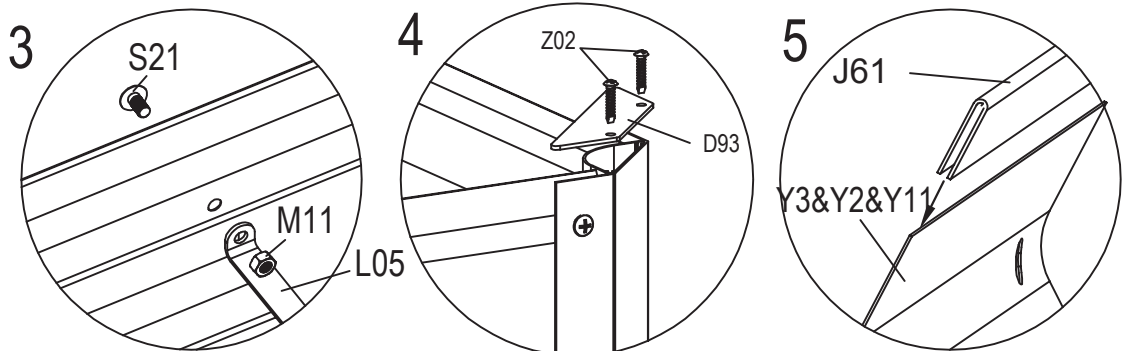

Strebenverstärkung

Fixieren Sie das Sicherheitsgummi J61 rund um die Randöffnung des Hochbeets wie in Abbildung 5 dargestellt. Bitte seien Sie während der Montage vorsichtig mit den scharfen Kanten des Hochbeets.

